

woodstory

500 series

Model Name: **UL-WS503**

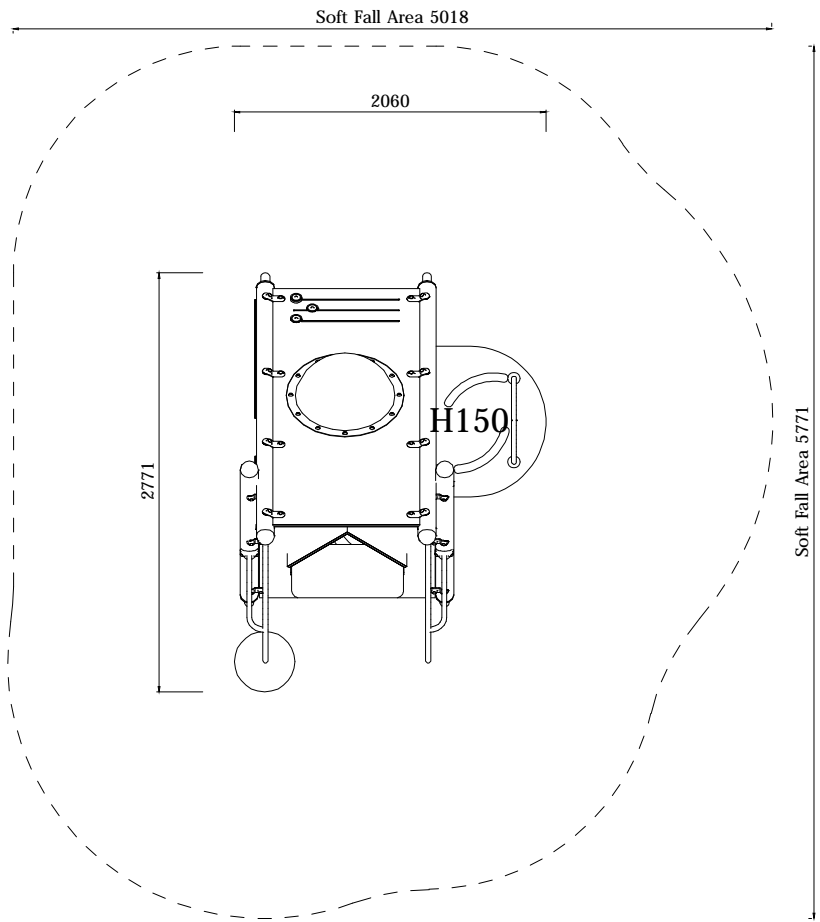



PLAN LAYOUT

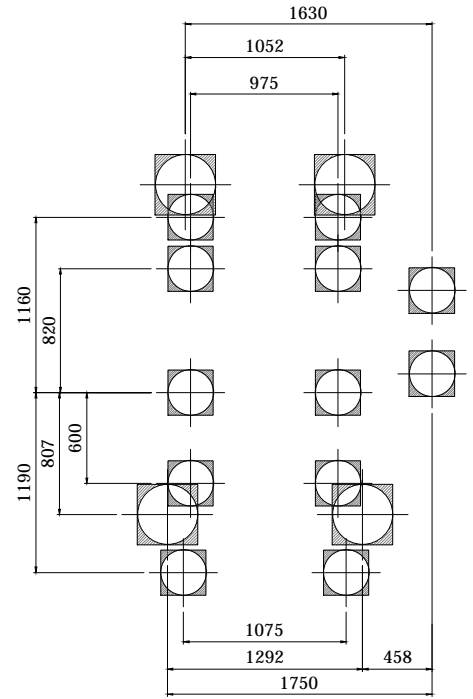

FOOTING LAYOUT

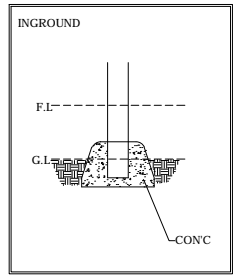

Scale : NTS

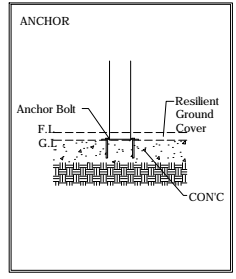

Scale : NTS

TYPICAL FOOTING DETAILS

Specification
Product Category : Wood Story - 500 Series
Model Name : UL-WS503
Standards: AS4685 Parts1-6 & 11 - 2014
Scale: 1:50 @ A4

- Summary:
- Play structure size : 2.8m x 2.1m
 - Approx. soft fall area : 23.9m²
 - Approx. soft fall size : 5.8m x 5.1m
 - Accommodates : 2 to 5 children
 - Overall height : 1.7m
 - Free height of fall : 0.2m



CRS Creative Recreation Solutions PTY LTD
 Address: Unit 1/25 Durgadin Drive Albion Park Rail NSW 2527
 Phone: (02) 4256 2991 Fax: (02) 4256 3991 E-mail: info@crs.net.au Web: www.crs.net.au

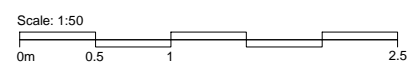

Note:
 • DO NOT mirror, reverse or reflect this design
 • DO NOT scale in any way
 If in doubt ask one of our friendly staff:
 Phone: (02) 4256 2991 E-mail: info@crs.net.au

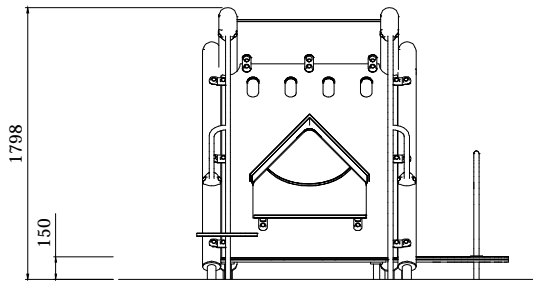

PLAN LAYOUT

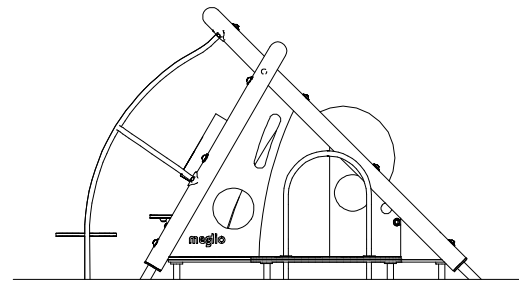

FOOTING LAYOUT

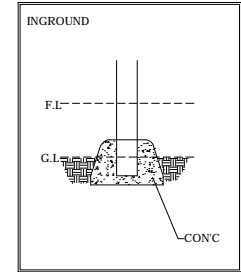

Scale : NTS

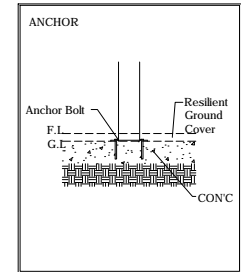

Scale : NTS

TYPICAL FOOTING DETAILS

Specification
Product Category : Wood Story - 500 Series
Model Name : UL-WS503
Standards: AS4685 Parts1-6 & 11 - 2014
Scale: 1:50 @ A4

Summary:

- Play structure size : 2.8m x 2.1m
- Approx. soft fall area : 23.9m²
- Approx. soft fall size : 5.8m x 5.1m
- Accommodates : 2 to 5 children
- Overall height : 1.7m
- Free height of fall : 0.2m

