

# woody

Model Name: **UL-WD510**

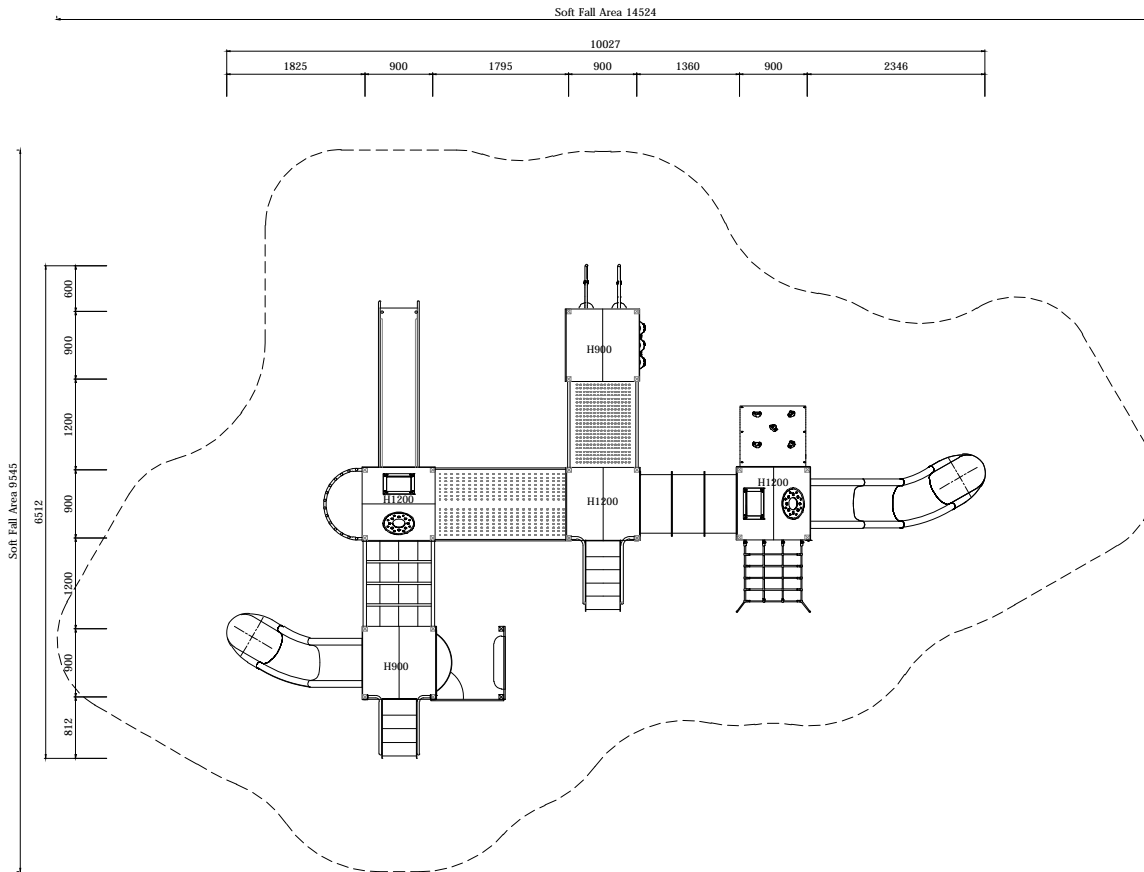



PLAN LAYOUT

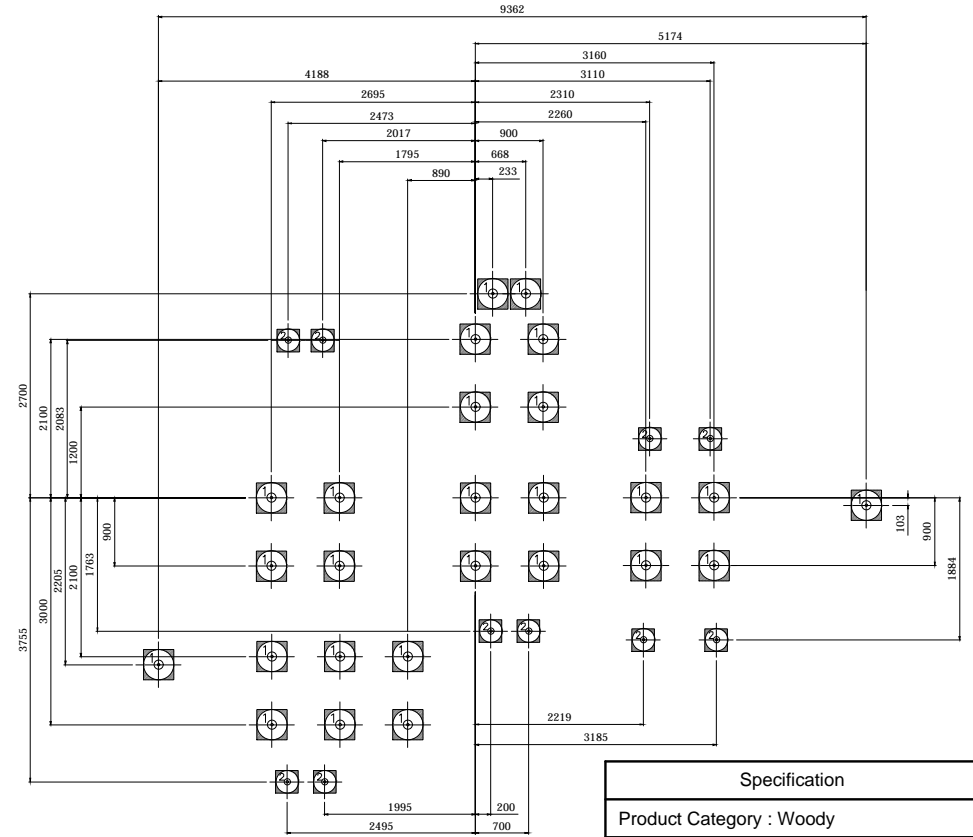

FOOTING LAYOUT

Specification
Product Category : Woody
Model Name : UL-WD510
Standards: AS4685 Parts1-6 & 11 - 2014
Scale: 1:100 @ A4

- Summary:
- Play structure size : 10.0m x 6.5m
  - Approx. soft fall area : 86.5m<sup>2</sup>
  - Approx. soft fall size : 14.5m x 9.5m
  - Accommodates : 30 to 35 children
  - Overall height : 3.8m
  - Free height of fall : 1.2m



CRS Creative Recreation Solutions PTY LTD  
 Address: Unit 1/25 Durgadin Drive Albion Park Rail NSW 2527  
 Phone: (02) 4256 2991 Fax: (02) 4256 3991 E-mail: info@crs.net.au Web: www.crs.net.au

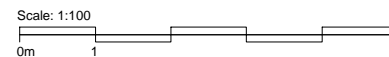

Note:  
 • DO NOT mirror, reverse or reflect this design  
 • DO NOT scale in any way  
 If in doubt ask one of our friendly staff:  
 Phone: (02) 4256 2991 E-mail: info@crs.net.au



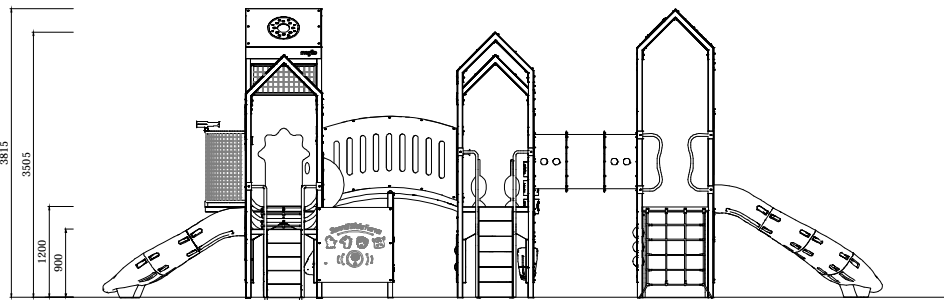

ELEVATION - FRONT

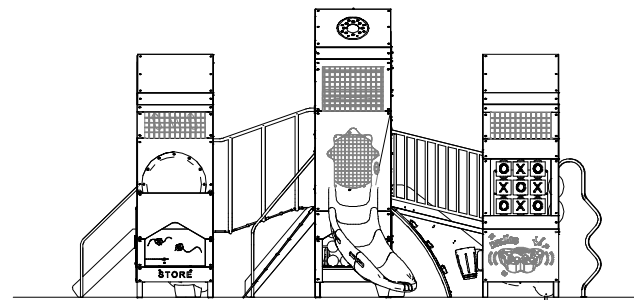

ELEVATION - RIGHT

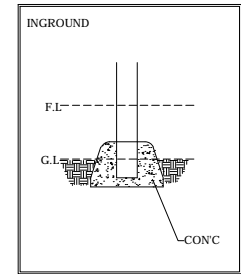

Scale : NTS

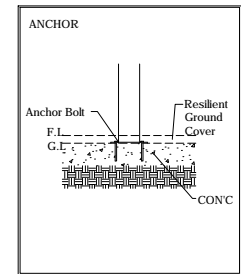

Scale : NTS

TYPICAL FOOTING DETAILS

Specification
Product Category : Woody
Model Name : UL-WD510
Standards: AS4685 Parts1-6 & 11 - 2014
Scale: 1:100 @ A4

Summary:

- Play structure size : 10.0m x 6.5m
- Approx. soft fall area : 86.5m<sup>2</sup>
- Approx. soft fall size : 14.5m x 9.5m
- Accommodates : 30 to 35 children
- Overall height : 3.8m
- Free height of fall : 1.2m



CRS Creative Recreation Solutions PTY LTD  
 Address: Unit 1/25 Durgadin Drive Albion Park Rail NSW 2527  
 Phone: (02) 4256 2991 Fax: (02) 4256 3991 E-mail: info@crs.net.au Web: www.crs.net.au

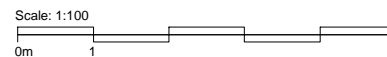

- Note:
- DO NOT mirror, reverse or reflect this design
  - DO NOT scale in any way

If in doubt ask one of our friendly staff:  
 Phone: (02) 4256 2991 E-mail: info@crs.net.au

