

woodstory

200 series

Model Name: **UL-WS206**

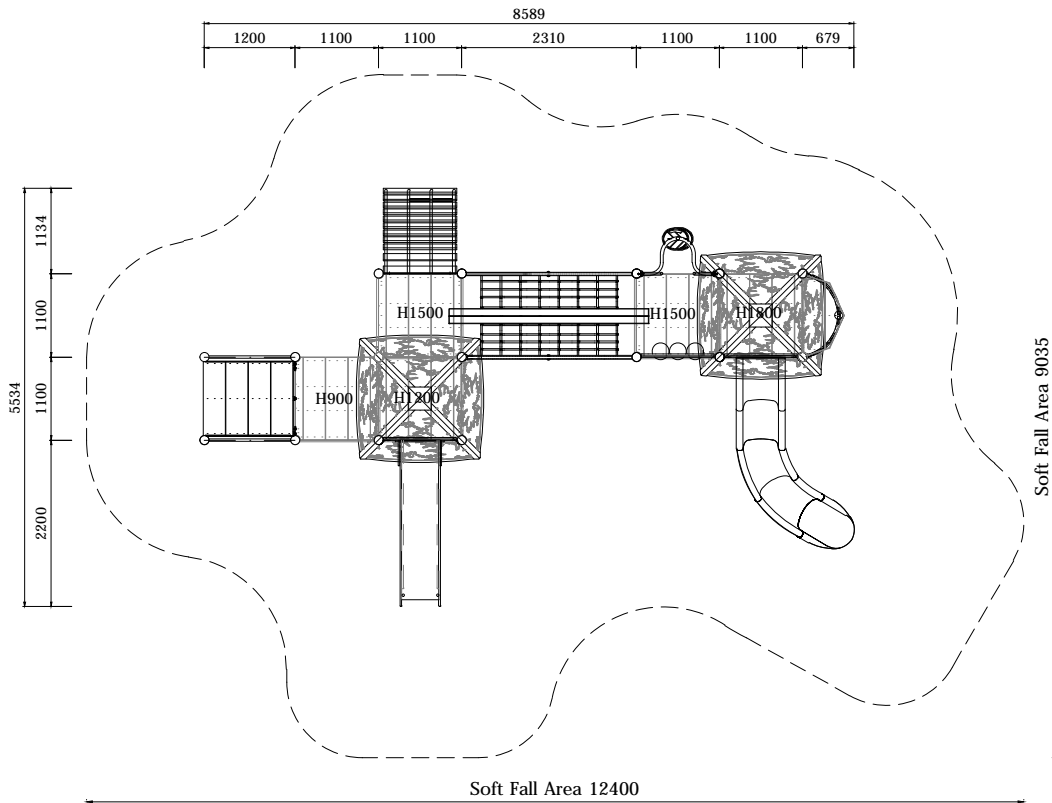



PLAN LAYOUT

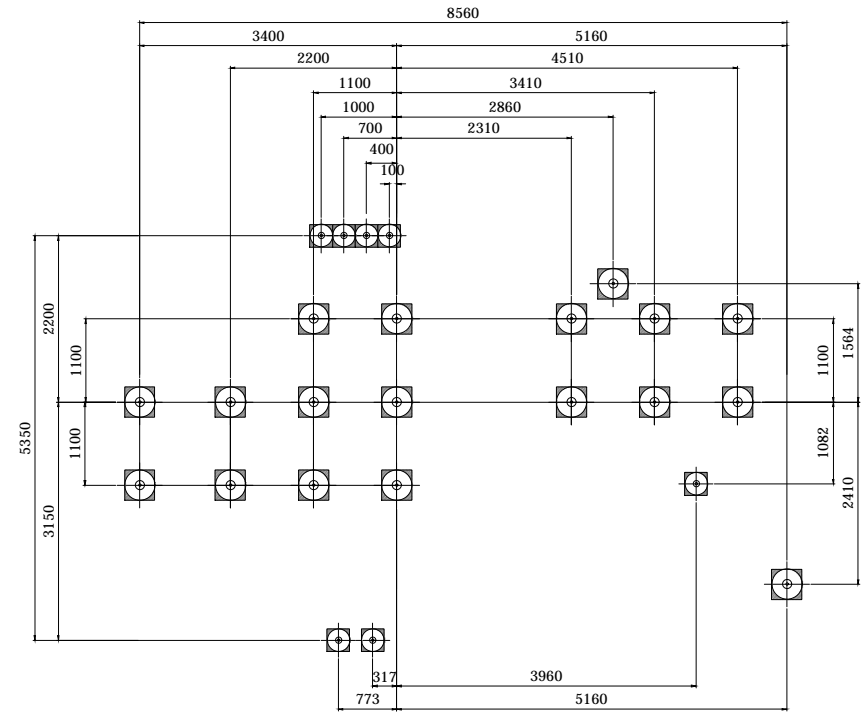

FOOTING LAYOUT

Specification
Product Category : Woodstory - 200 Series
Model Name : UL-WS206
Standards: AS4685 Parts1-6 & 11 - 2014
Scale: 1:100 @ A4

- Summary:
- Play structure size : 5.6m x 4.2m
 - Approx. soft fall area : 46.1m²
 - Approx. soft fall size : 9.0m x 7.1m
 - Accommodates : 30 to 35 children
 - Overall height : 4.6m
 - Free height of fall : 1.8m



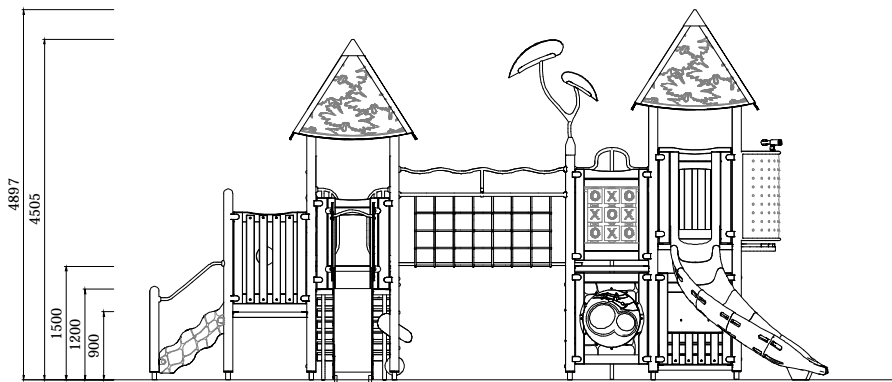

ELEVATION - FRONT

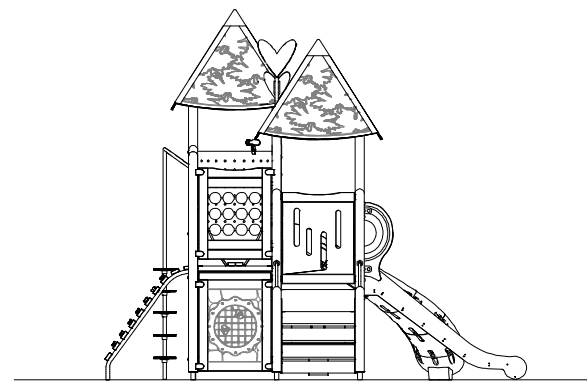

ELEVATION - RIGHT

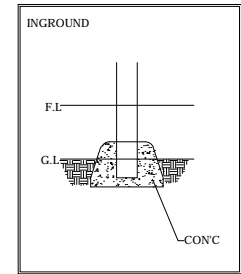

Scale : NTS

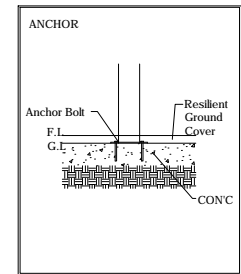

Scale : NTS

TYPICAL FOOTING DETAILS

Specification
Product Category : Woodstory - 200 Series
Model Name : UL-WS206
Standards: AS4685 Parts1-6 & 11 - 2014
Scale: 1:100 @ A4

Summary:

- Play structure size : 5.6m x 4.2m
- Approx. soft fall area : 46.1m²
- Approx. soft fall size : 9.0m x 7.1m
- Accommodates : 30 to 35 children
- Overall height : 4.6m
- Free height of fall : 1.8m



CRS Creative Recreation Solutions PTY LTD
 Address: Unit 1/25 Durgadin Drive Albion Park Rail NSW 2527
 Phone: (02) 4256 2991 Fax: (02) 4256 3991 E-mail: info@crs.net.au Web: www.crs.net.au

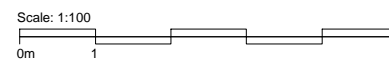

Note:
 • DO NOT mirror, reverse or reflect this design
 • DO NOT scale in any way

If in doubt ask one of our friendly staff:
 Phone: (02) 4256 2991 E-mail: info@crs.net.au

