

CLIMBING & BALANCING

# UKI Dynamic

Model Name: **UKI-DY105-3**

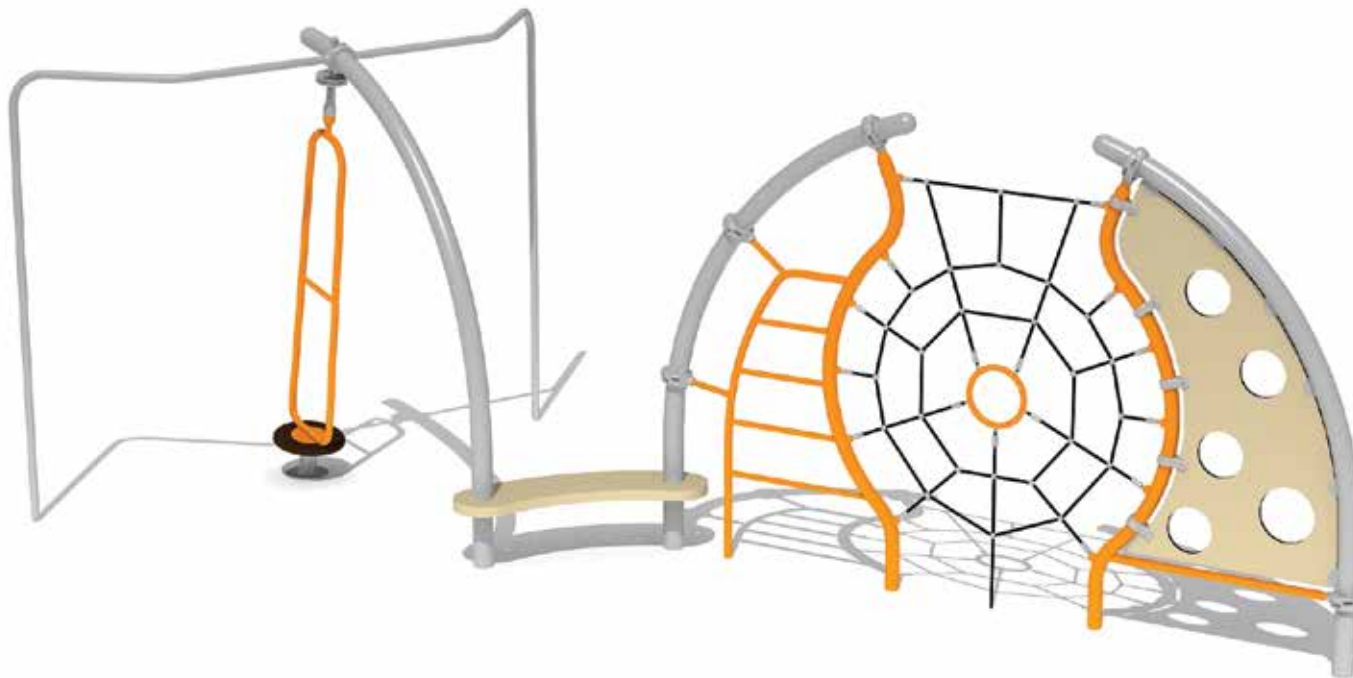

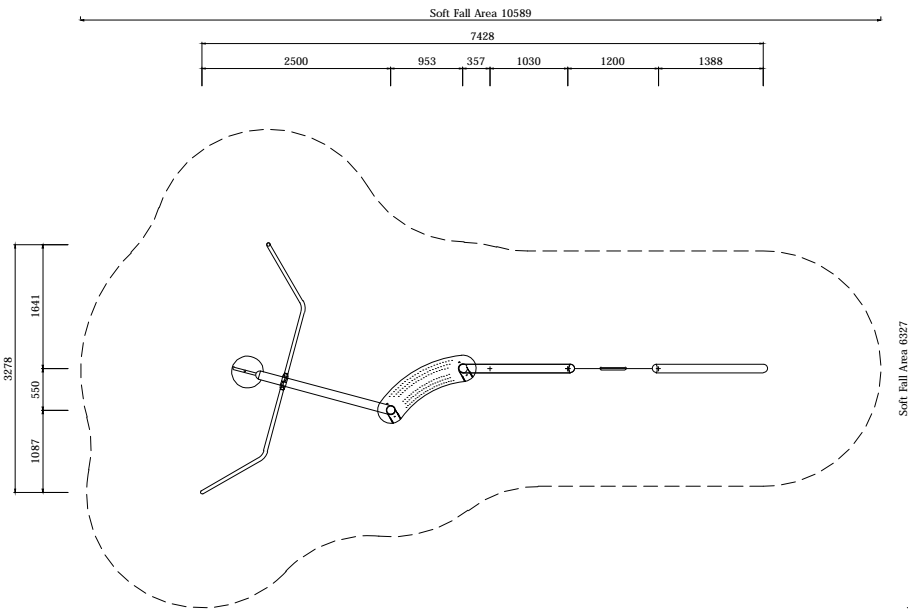

PLAN LAYOUT

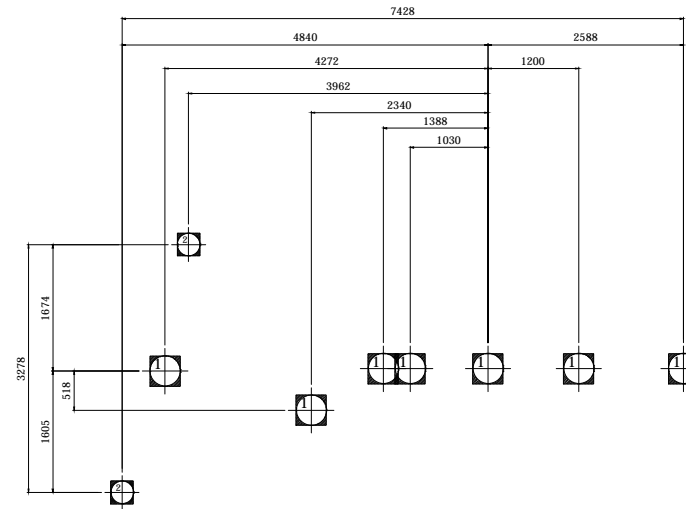

FOOTING LAYOUT

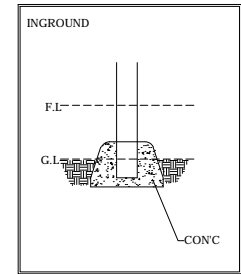

Scale : NTS

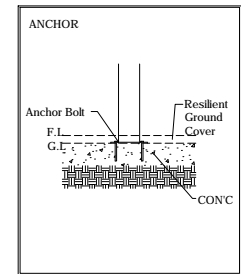

Scale : NTS

TYPICAL FOOTING DETAILS

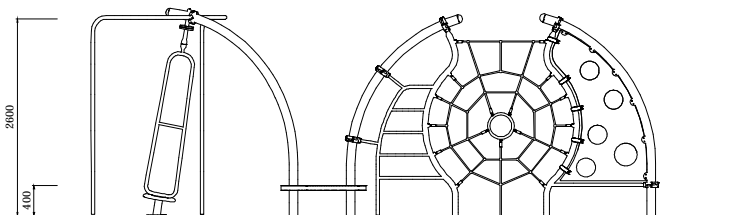

ELEVATION - FRONT

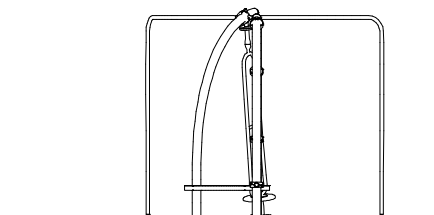

ELEVATION - RIGHT

Specification

Product Category : UKI Dynamic

Model Name : UKI-DY105-3

Standards: AS4685 Parts1-6 & 11 - 2014

Scale: 1:100 @ A4

Summary:

- Play structure size : 7.4m x 3.3m
- Approx. soft fall area : 41.1m<sup>2</sup>
- Approx. soft fall size : 10.6m x 6.3m
- Accommodates : 10 to 15 children
- Overall height : 2.6m
- Free height of fall : 1.9m

