

# woodstory

300 series

Model Name: **UL-WS303-1**

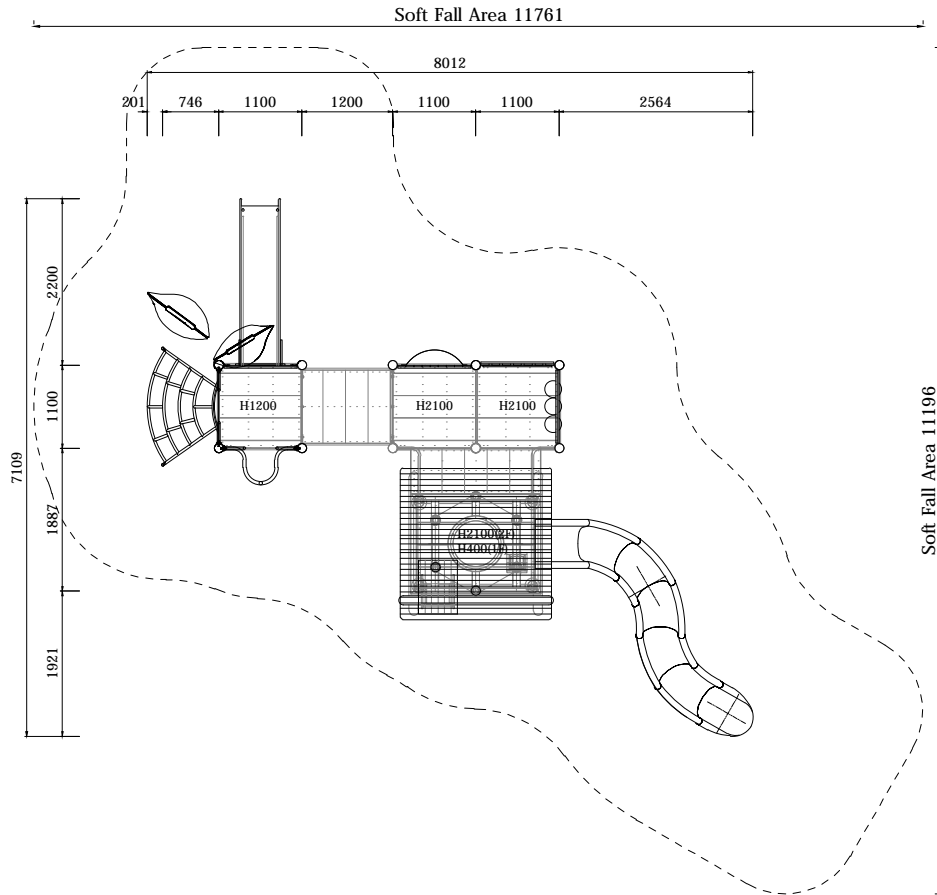



PLAN LAYOUT

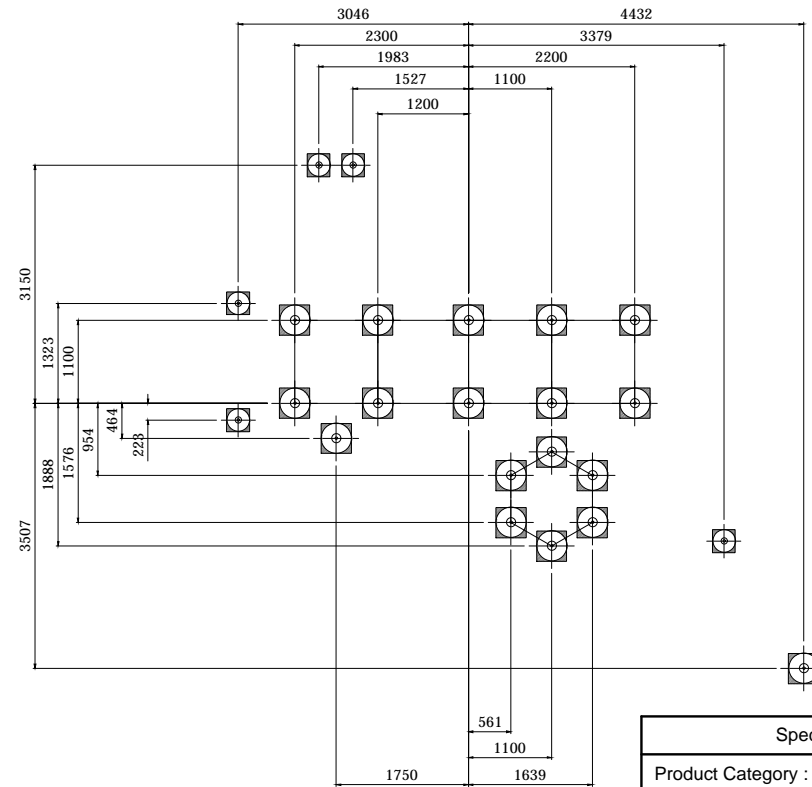

FOOTING LAYOUT

Specification
Product Category : Woodstory - 300 Series
Model Name : UL-WS303-1
Standards: AS4685 Parts 1-6 & 11 - 2014
Scale: 1:100 @ A4

- Summary:
- Play structure size : 8.0m x 7.1m
  - Approx. soft fall area : 67.4m<sup>2</sup>
  - Approx. soft fall size : 11.8m x 11.2m
  - Accommodates : 25 to 30 children
  - Overall height : 5.4m
  - Free height of fall : 2.1m



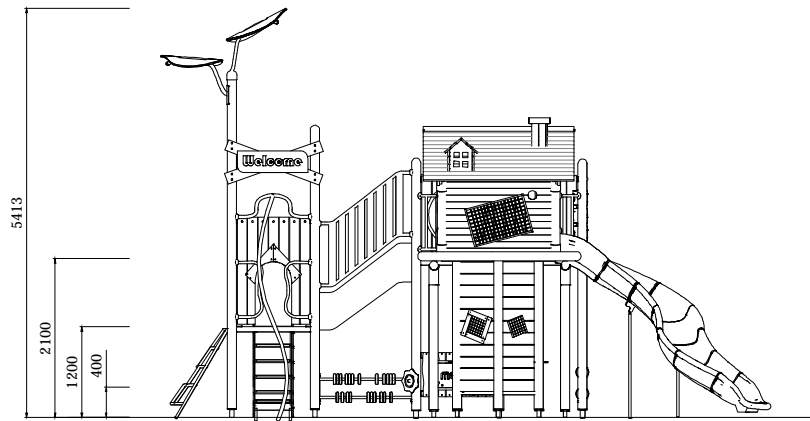

ELEVATION - FRONT

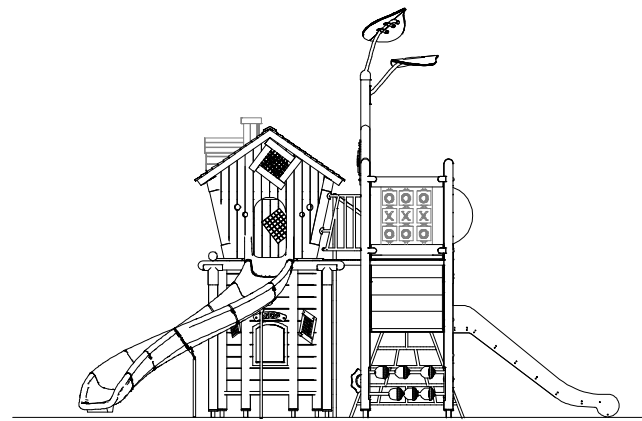

ELEVATION - RIGHT

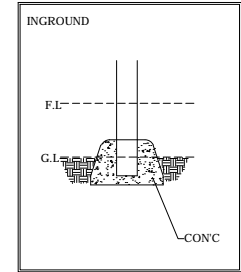

Scale : NTS

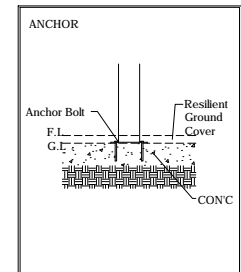

Scale : NTS

TYPICAL FOOTING DETAILS

Specification
Product Category : Woodstory - 300 Series
Model Name : UL-WS303-1
Standards: AS4685 Parts1-6 & 11 - 2014
Scale: 1:100 @ A4

Summary:

- Play structure size : 8.0m x 7.1m
- Approx. soft fall area : 67.4m<sup>2</sup>
- Approx. soft fall size : 11.8m x 11.2m
- Accommodates : 25 to 30 children
- Overall height : 5.4m
- Free height of fall : 2.1m



CRS Creative Recreation Solutions PTY LTD  
 Address: Unit 1/25 Durgadin Drive Albion Park Rail NSW 2527  
 Phone: (02) 4256 2991 Fax: (02) 4256 3991 E-mail: info@crs.net.au Web: www.crs.net.au

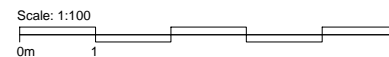

Note:  
 • DO NOT mirror, reverse or reflect this design  
 • DO NOT scale in any way

If in doubt ask one of our friendly staff:  
 Phone: (02) 4256 2991 E-mail: info@crs.net.au

