

UL - MODULAR PLAY SYSTEMS

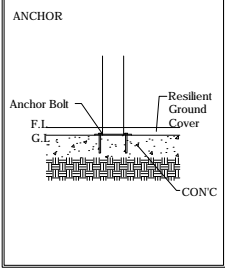

Model Name: **UL-US502**

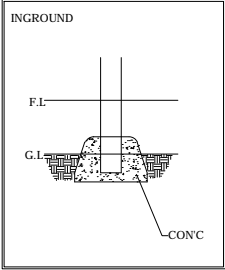

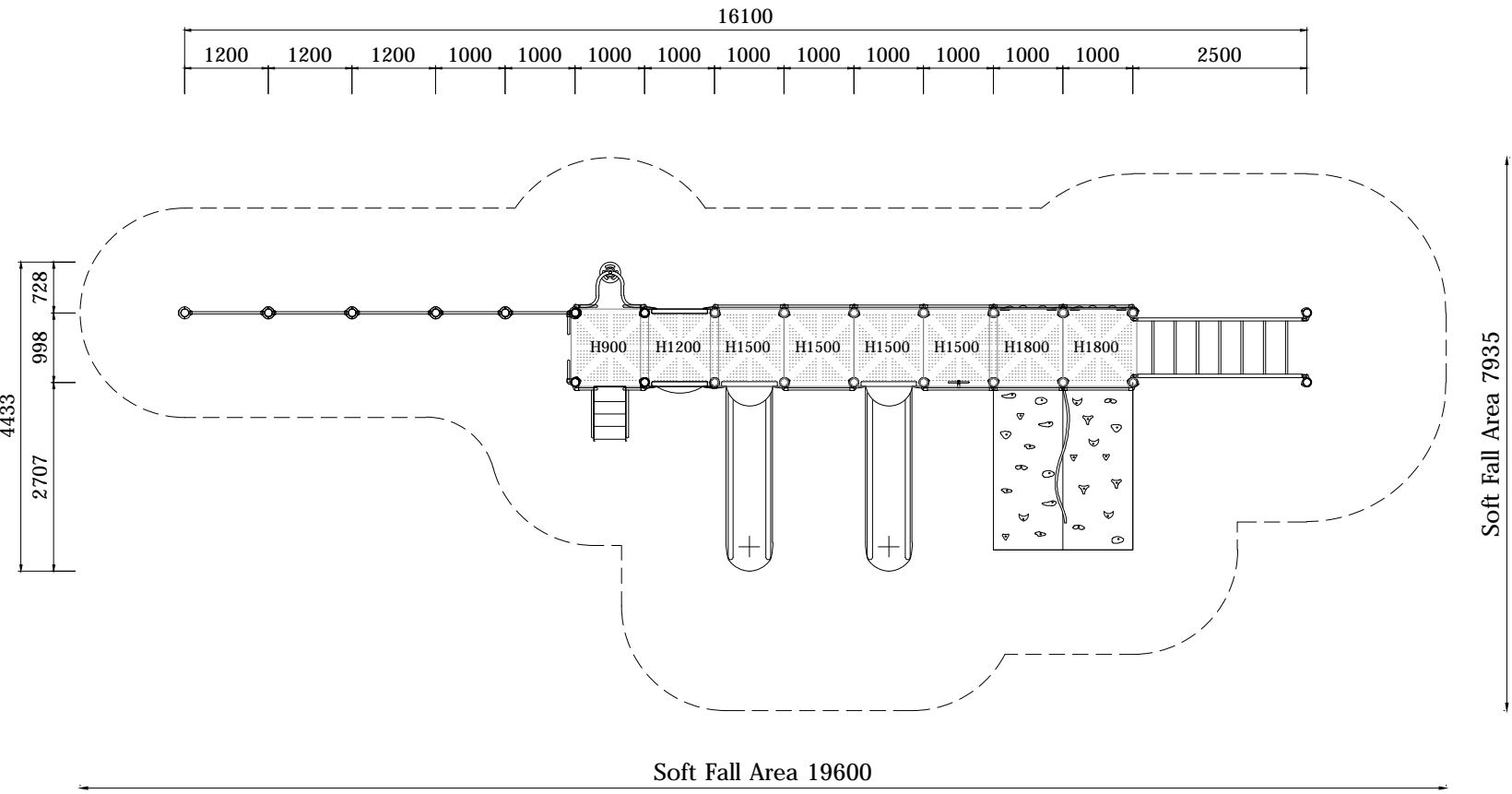

TYPICAL FOOTING DETAILS

Specification
Product Category : Ultra Stainless Play Systems
Model Name : UL-US502
Standards: AS4685 Parts1-6 & 11 - 2014
Scale: 1:100 @ A4

- Summary:
- Play structure size : 16.1m x 4.4m
 - Approx. soft fall area : 101.1m²
 - Approx. soft fall size : 19.6m x 7.9m
 - Accommodates : 40 to 45 children
 - Overall height : 3.0m
 - Free height of fall : 1.8m



CRS Creative Recreation Solutions PTY LTD
 Address: Unit 1/25 Durgadin Drive Albion Park Rail NSW 2527
 Phone: (02) 4256 2991 Fax: (02) 4256 3991 E-mail: info@crs.net.au Web: www.crs.net.au

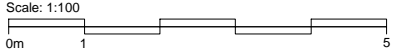

Note:
 • DO NOT mirror, reverse or reflect this design
 • DO NOT scale in any way
 If in doubt ask one of our friendly staff:
 Phone: (02) 4256 2991 E-mail: info@crs.net.au

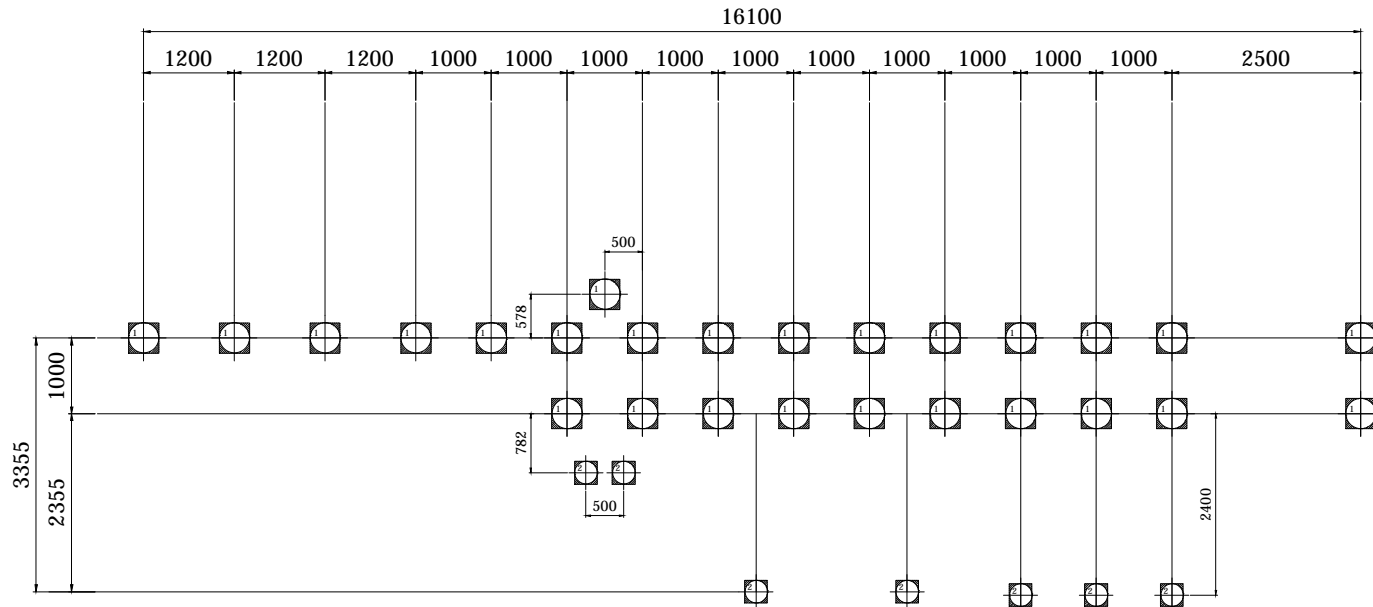

FOOTING LAYOUT

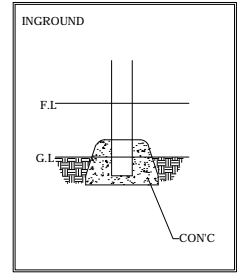

Scale : NTS

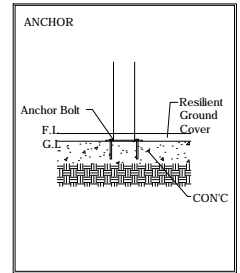

Scale : NTS

TYPICAL FOOTING DETAILS

Specification
Product Category : Ultra Stainless Play Systems
Model Name : UL-US502
Standards: AS4685 Parts1-6 & 11 - 2014
Scale: 1:100 @ A4

- Summary:
- Play structure size : 16.1m x 4.4m
 - Approx. soft fall area : 101.1m²
 - Approx. soft fall size : 19.6m x 7.9m
 - Accommodates : 40 to 45 children
 - Overall height : 3.0m
 - Free height of fall : 1.8m



CRS Creative Recreation Solutions PTY LTD
 Address: Unit 1/25 Durgadin Drive Albion Park Rail NSW 2527
 Phone: (02) 4256 2991 Fax: (02) 4256 3991 E-mail: info@crs.net.au Web: www.crs.net.au

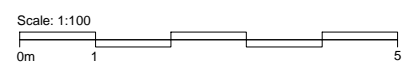

Note:
 • DO NOT mirror, reverse or reflect this design
 • DO NOT scale in any way
 If in doubt ask one of our friendly staff:
 Phone: (02) 4256 2991 E-mail: info@crs.net.au



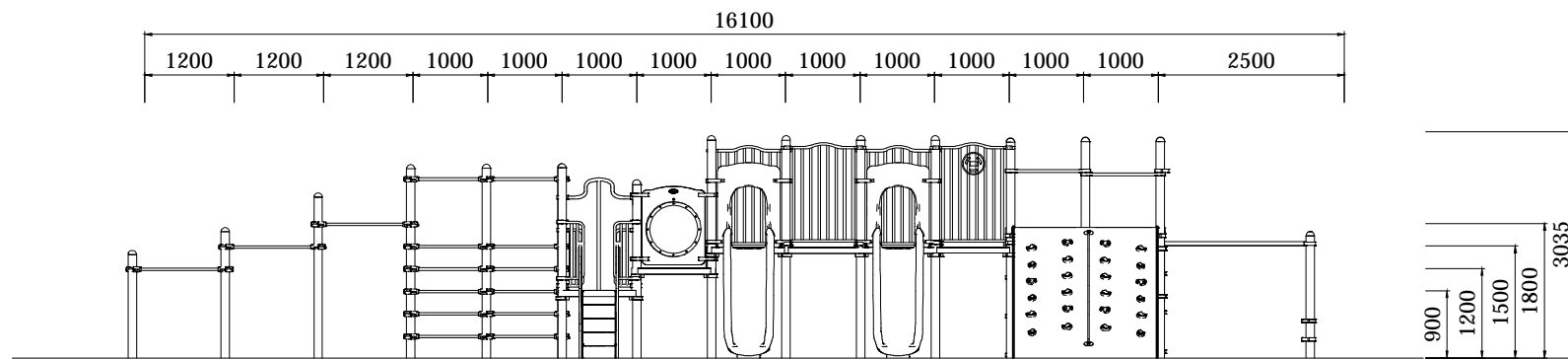

ELEVATION - FRONT

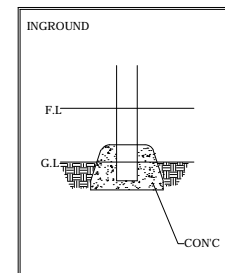

Scale : NTS

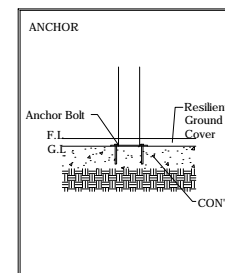

Scale : NTS

TYPICAL FOOTING DETAILS

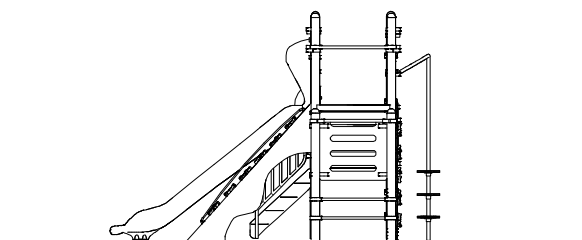
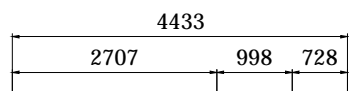

ELEVATION - RIGHT

Specification
Product Category : Ultra Stainless Play Systems
Model Name : UL-US502
Standards: AS4685 Parts1-6 & 11 - 2014
Scale: 1:100 @ A4
Summary: <ul style="list-style-type: none"> Play structure size : 16.1m x 4.4m Approx. soft fall area : 101.1m² Approx. soft fall size : 19.6m x 7.9m Accommodates : 40 to 45 children Overall height : 3.0m Free height of fall : 1.8m



CRS Creative Recreation Solutions PTY LTD
 Address: Unit 1/25 Durgadin Drive Albion Park Rail NSW 2527
 Phone: (02) 4256 2991 Fax: (02) 4256 3991 E-mail: info@crs.net.au Web: www.crs.net.au

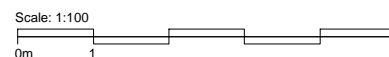

Note:
 • DO NOT mirror, reverse or reflect this design
 • DO NOT scale in any way
 If in doubt ask one of our friendly staff:
 Phone: (02) 4256 2991 E-mail: info@crs.net.au

